



SL-TO1 SL-Series Terreon® Undermount Basins

- Bowl(s) are constructed of Terreon® solid surface material
- Integrate with Terreon solid surface counters to create a seamless look
- Available in a variety of colors
- Ideal for commercial handwashing applications
- ADA and ANSI Compliant when mounted at required dimensions

Specifications

Specify on model LD-3010, a prefabricated OmniDeck or as a stand alone basin with countertop material of your choice, including Terreon sheet goods (Model TSA) or other cast polymer material.

Construction

Constructed of Terreon, a densified solid surface material composed of a bio-based resin. Terreon is resistant to chemicals, stains, burns, and impact. Surface damage can be easily repaired with everyday cleansers or fine grit abrasives. Terreon is GREENGUARD® certified as low-emitting materials.

Standard Height Mounting

To comply with ADA, the rim height of the counter or deck, and at least one bowl, must be 34" above the finished floor and must have proper knee and toe clearances. Always review local codes for compliance.

Juvenile Height Mounting

The rim height of the counter or deck must be no higher than 31" above finished floor and must have proper knee and toe clearances in order to comply with ADA Accessibility Guidelines for Building and Facilities: Building Elements Designed for Children's use; Final Rule. Always review local codes for compliance.

Product Compliance

Listed by IAPMO R&T to

- Uniform Plumbing Code (UPC)
- National Plumbing Code of Canada
- International Plumbing Code (IPC)
- IGC 156 and the requirements of CSA B45.5/ IAPMO Z124 and ASME A112.18.1/CSA B125.1



Listed by UL Environment to

- GreenGuard Gold



Complies with

- ADA
- ICC/ANSI 117.1



Sustainability

Terreon participates in the mindful MATERIALS library.



Verify all rough-in dimensions prior to installation.

Consult local and national codes. Conformity and compliance to local and national codes is the responsibility of the installer.



SL-T01
Oval Undermount Bowl
with Molded Overflow

Finishes

 Click on any color swatch to view as a larger image.

-  Polished Chrome
-  Brushed Black Stainless*
-  Brushed Stainless*
-  Brushed Bronze*
-  Brushed Brass*
-  Brushed Nickel*

*PVD Finishes, see PVD Finishes section.

* PVD Finishes

Physical Vapor Deposition is an intricate, environmentally friendly finishing process that molecularly bonds the finish to the faucet, creating a very hard, durable surface that will not corrode, discolor, or tarnish.

Drain Assembly

- Includes strainer and straight tailpiece
- Grid strainer available in polished chrome or PVD finishes

Basin Mounting Method

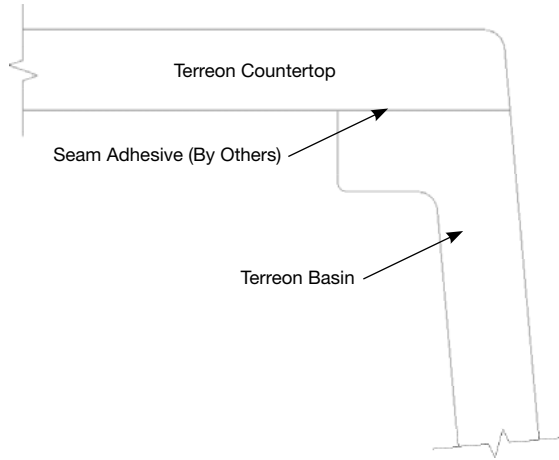

Dimensions

(mm)

Top View

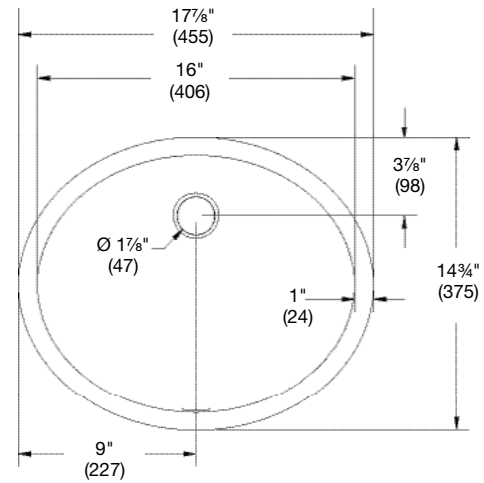

Side View

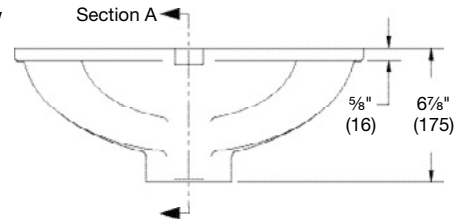

Section A

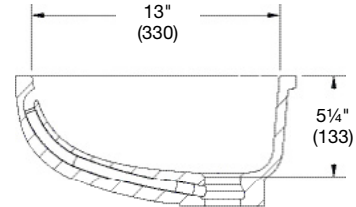

Color Matching and Installation Considerations

- Basins are to be installed by a licensed fabricator.
- Proper seam, joint integrity and bowl location are the responsibility of the fabricator.
- Fabricator to ensure proper seam adhesive color match between basin and counter.
- Specifications with sheet and basin(s) of the same solid color will require close inspection for acceptable color match before fabrication. Bradley does not guarantee an exact color match between individual sinks and sheets of the same color.
- Prefabricated product available with Bradley model LD-3010.

Undermount Straight Drain Assmly

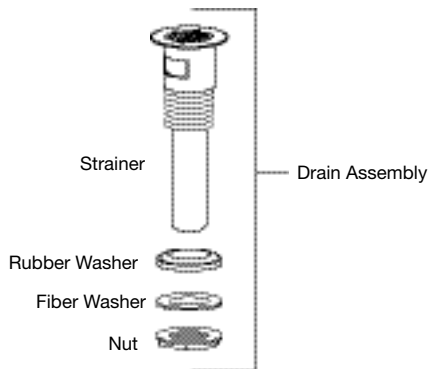

Verify all rough-in dimensions prior to installation.

Consult local and national codes. Conformity and compliance to local and national codes is the responsibility of the installer.









A WATTS Brand

SL-TO1 SL-Series Terreon® Undermount Basins

Standard Selections (Must select one from each category)

Drain Assembly Type

Straight Tailpiece

- D-ASSY-PC**  Drain Assembly w/Polished Chrome Grid Strainer Finish
- D-ASSY-BB**  Drain Assembly w/Brushed Black Stainless Grid Strainer Finish
- D-ASSY-BS**  Drain Assembly w/Brushed Stainless Grid Strainer Finish
- D-ASSY-BZ**  Drain Assembly w/Brushed Bronze Grid Strainer Finish
- D-ASSY-BR**  Drain Assembly w/Brushed Brass Grid Strainer Finish
- D-ASSY-BN**  Drain Assembly w/Brushed Nickel Grid Strainer Finish
- NONE** None

Color of Terreon Bowl

NOTE: Click on any swatch to view as a larger image.

Solid Colors

- ALP-WHT** Alpine White
- DS-WHT** Designer White

Standard Colors

- | | |
|---|---|
| CHAR  Charcoal Gray* | PEP-WHT <input type="checkbox"/> Peppered White |
| DRIFT  Driftwood† | POLAR <input type="checkbox"/> Polar Ice† |
| E-GRAY  Empire Gray | RIVER  Riverstone |
| GLACIER <input type="checkbox"/> Glacier | SAND  Sandtrap |
| GRAPH  Graphite* | S-CREEK  Stone Creek* |
| LANNON  Lannonstone | S-MIST  Silver Mist |
| MOONSTONE  Moonstone† | WHT-SAND <input type="checkbox"/> White Sand |
| PEBBLE  Pebble Beach | |

† This color contains large, randomly distributed chips.

* Requires tempered water supply (less than 110°F or 43°C).

Verify all rough-in dimensions prior to installation.

Consult local and national codes. Conformity and compliance to local and national codes is the responsibility of the installer.